

PAA3X

Highly Accurate Handheld Audio Analyzer



Features

- ▶ 31-band and 61-band real time spectrum analyzer
- ▶ 31-band and 61-band EQ setting value display (Boost/Cut)
- ▶ Detachable calibrated measurement microphone
- ▶ Includes 5m mic cable for remote placement of measurement mic, perfect for home theater and automotive application
- ▶ SPL meter and level meter with three level range selections
- ▶ Sound pressure level meter from 30 dB to 130 dB
- ▶ Line signal measurement display in dBu, dBV, or Volts (AC)
- ▶ Polarity function for checking phase of any loudspeaker
- ▶ Microphone calibration possible using standard 94dB sound level calibrator (sold separately)
- ▶ Snapshot button for instant screen captures saved to SD card
- ▶ Signal generator with pink noise, sine wave, sweep wave and polarity test signal
- ▶ A, B, C and flat weightings all available for measurements
- ▶ Maximum level and peak hold display
- ▶ Balanced XLR input and output connectors
- ▶ Rechargeable lithium-ion battery
- ▶ Micro USB port for charging battery
- ▶ AC power adapter and USB cable included
- ▶ Mic stand included for flexible mic placement

Description

Developed on the shoulders of the incredibly popular PAA3, the PAA3X inherits all the widely praised features of its predecessor but with many refinements, new functions, and an all-new design. Expect a rich array of sound analysis tools, including 31-band and 61-band real-time spectrum analysis, RT60 reverb time analyzer, sound pressure and line meters, internal signal generator, EQ setting calculation, microphone calibration, and speaker polarity checking abilities. The inclusion of a snapshot button enables you to take instant screen captures and save them to an SD card for later reference. The detachable measurement microphone and included 5 meter extension cable mean measurements can be taken remotely, ideal for measuring high SPLs when you really don't want to be in the room. With a rechargeable lithium-ion battery, the PAA3X is the must-have tool for every serious audio engineer.

Product Overview

Detachable Precision Mic
Phonic's famous precision condenser microphone

Top-mounted Power Button

Color LCD Display
View all functions

Micro SD Card Slot
Snapshots are saved here

Jog Wheel Control
Adjust settings and functions

Standard Controls
↑/←, ↓/→ and enter buttons

Snapshot Button
Instantly capture the screen

USB Charging Port
Charge the lithium-ion battery

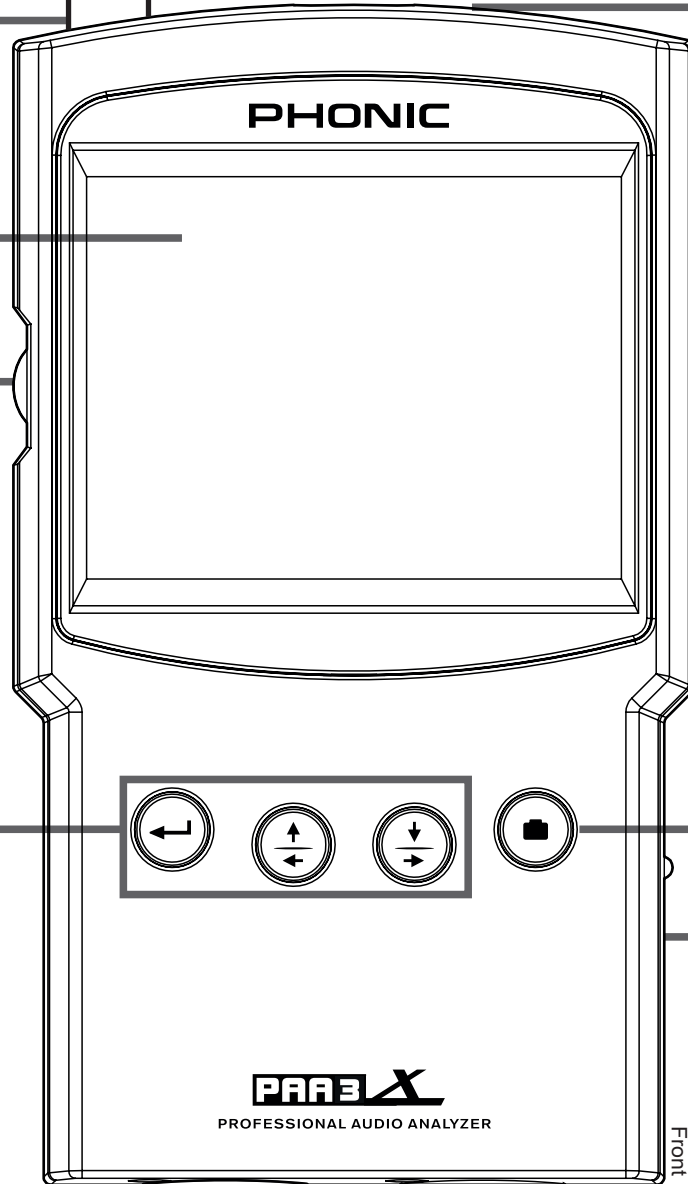

Balanced XLR Input Connectors
For taking measurements

Balanced XLR Output Connectors
For signal generator output

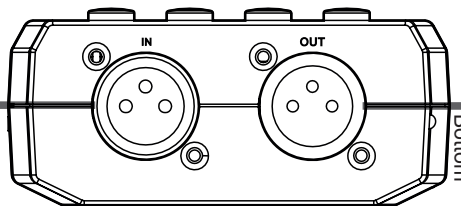

Included Accessories

Highly Accurate Detachable Measurement Microphone

Microphone Stand Adapter for PAA3X

Adjustable Microphone Stand Adapter Allows Versatile Mic Placement

5m Mic Signal Extension Cable

SD Card and Plastic Case

USB Charging Cable and Adapter

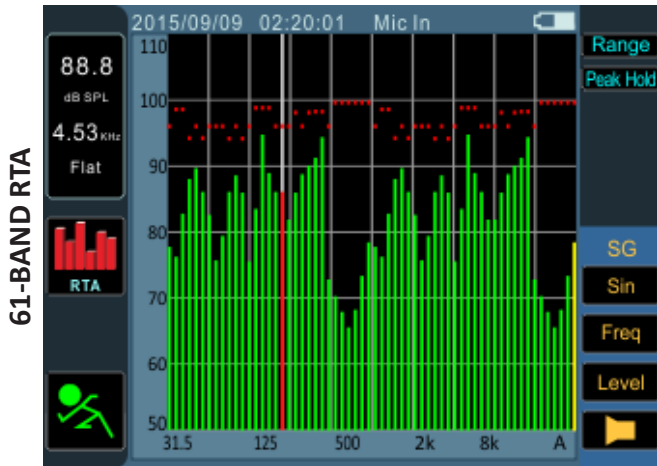

61-BAND RTA

Use the 1/6th octave RTA to better understand the subtle nuances of your audio; get a visual cue on what you're hearing to better refine your live system.

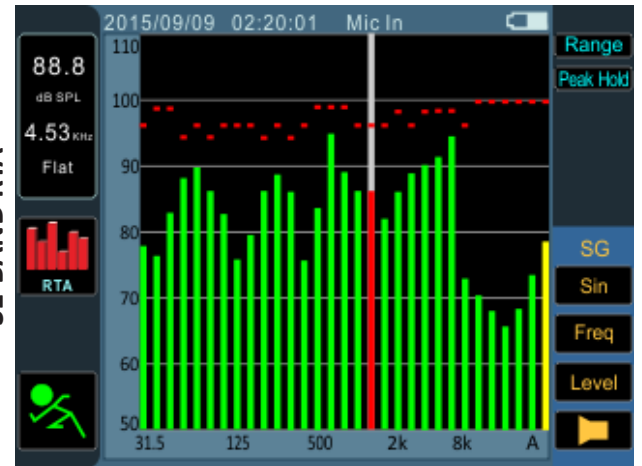

31-BAND RTA

When you don't need the information overload provided by the 1/6th octave RTA, this modest 1/3rd octave analyzer is your new best friend.

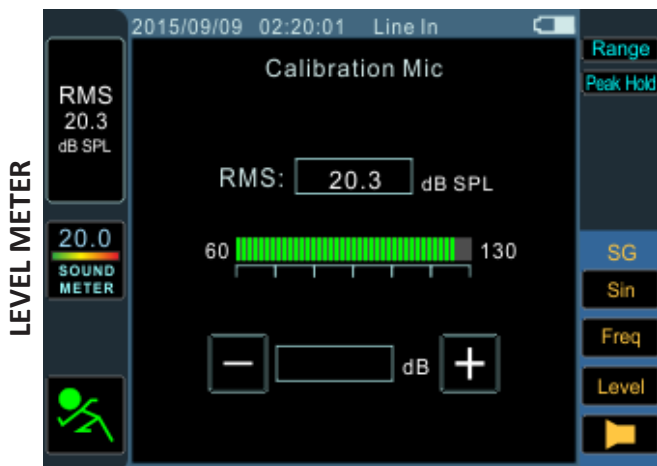

LEVEL METER

The PAA3X includes a highly accurate sound pressure level meter in addition to a line meter that measures in dBu, dBV and voltage.

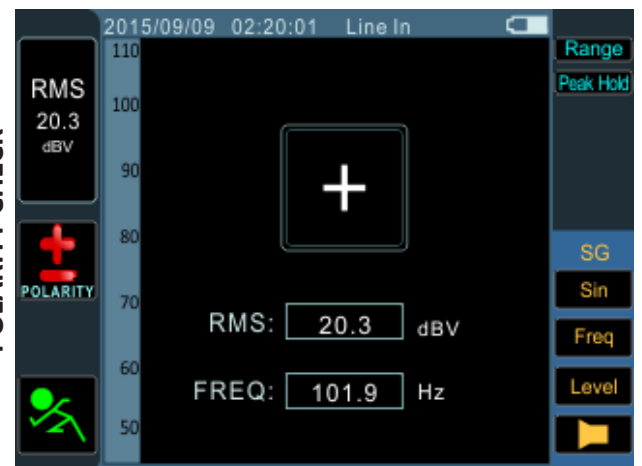

POLARITY CHECK

Simply check if your speakers are wired correctly by running the polarity signal through your system and using this function. It will tell you immediately.

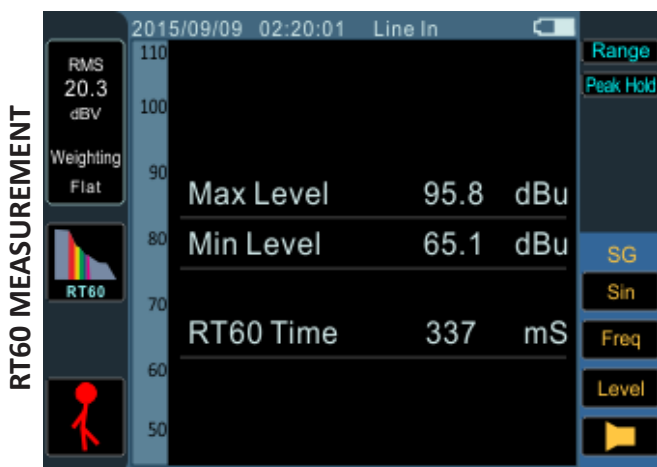

RT60 MEASUREMENT

Measure the reverb time of any room and see the decay time to the nearest millisecond. Phonic also provides maximum and minimum level information.

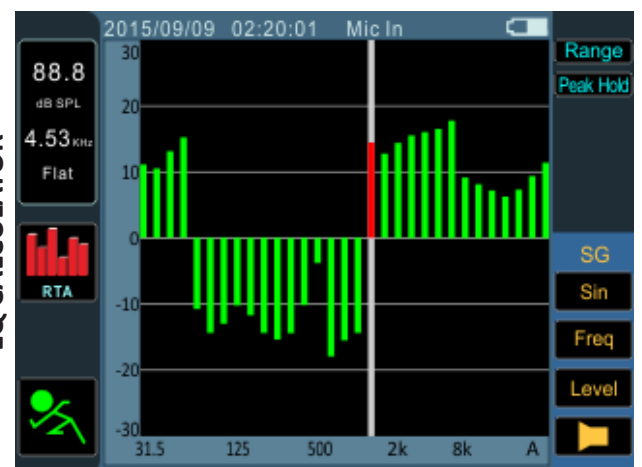

EQ CALCULATOR

View suggested EQ settings based on measurements taken from the precision microphone and the internal algorithm that knows sound better than the human ear.

Dimensions

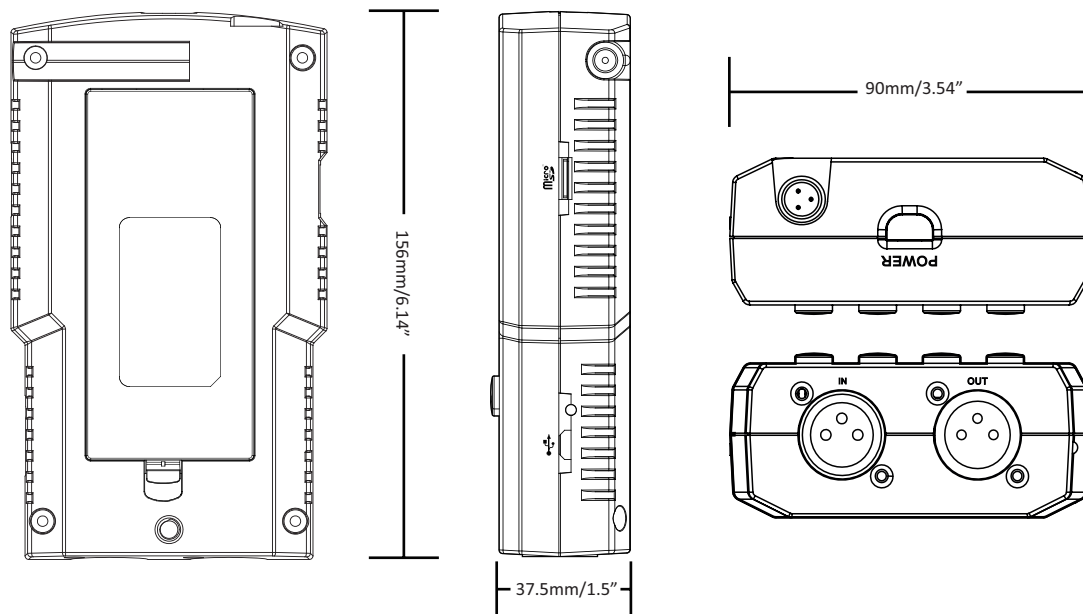

Specifications

Input/Output

Microphone	Detachable miniature condenser microphone
Line	Balanced XLR jacks for line input and output
Display	320 x 240 RGB LCD
SPL, dBu, dBV, Voltage	Bar graph and digital display
RTA	1/3rd octave and 1/6th octave, 0.5 dB resolution Center frequencies ISO standard from 20Hz to 20KHz

Measured Range

SPL (Microphone Input)	30 to 130 dB SPL
dBu (Line Input)	-50 to +40 dBu
dBV (Line Input)	-52 to +38 dBV
Voltage (Line Input)	5mV to 80V

Settings

Weighting	A, B, C or Flat
Peak Hold	ON/OFF
Maximum Level Display	RESET
Response Time	35 ms, 125 ms, 250 ms, 1 second

Other Functions

RT60	Reverb time display, up to 30 seconds
Memory	Micro SD storage slot
EQ Setting Value Display	31-band / 61-band
Polarity Checker	Positive or Negative (using polarity signal)
Signal Generator	Pink noise, sine wave, sweep wave, polarity signal
Signal Generator Output	Balanced XLR Output
Power Source	Rechargeable Lithium-ion Battery
Charging Port	Micro USB
Dimensions (H x W x D)	156 x 90 x 37.5 mm (6.14" x 3.54" x 1.5")
Weight	325 g (0.7 lbs)